

## **Part 2 Free Network Foundation**

### *DIY Commons Infrastructure in the US*

## Breaking News:

### ***The FreeNetwork Foundation to Join Forces with guifi.net***

Big things sometimes happen in the most off-handed way. Isaac got back to Kansas City on January 30 and is meeting with his constituents on January 31 and February 1. He is presenting to them what he outlines below. If there is no objection the following will go into effect even before we visit Catalonia.

**Isaac Wilder:** As our familiarity with [guifi.net](http://guifi.net) grows – through working with Gordon on this report and otherwise – it becomes increasingly self-evident that collaborating with guifi.net is our very best bet for driving stateside adoption of free networks.

During the last weekend of January (2013), the FNF held an executive summit in Austin, TX. In the course of an exuberant 5-hour discussion on the second night, it seemed to all fall into place. Guifi had a solution for the component that was still missing from our thinking: ***a way to support networking building at scale. Their GIS system, which is explored in this document, allows individuals and communities to interface with the network, and offers a self-service path to participation.***

After many conversations with the Guifi's core team, with our Kansas City constituents, with Gordon and with ourselves, we have decided to launch [guifi.us](http://guifi.us) - a GIS and Decision Support engine that will allow folks to get involved in the project of owning, rather than renting, their means of communication. There is much to be done before we launch the platform on March 9th – we are extremely sanguine about these developments, and feel that this is just the beginning of the guifi.us story.

**COOK Report:** Much of life is chance. On December 1, 2012 Isaac asked me if I would be willing to take a look at an overseas network. He told me there were several but the one in Catalonia called guifi.net was by far the largest. Ramon gave me the initial two hour 45 minute interview on December 6 finishing at about 1:30 am his time the 7<sup>th</sup>. Very much excited I called isaac the next day and said "this is your proof of concept. It can be done." On January 3, 2013 Ramon went out of his way to schedule a demonstration for both Isaac and myself on how zones and nodes were created. Self-service is a good way to describe it and it does grow organically. Ramon showed Isaac CONFINE while I was working on this report and when I realized that Isaac was in Austin with his core group, I said "you have my current draft PLEASE circulate it to everyone." Isaac did and I gather that this played a significant role in catalyzing what happened next. At any rate I could not be happier about what is happening. In true do-it-ourselves form -- get the right people together and a new world builds itself bottom up.

# Free Network Foundation Launches Kansas City FreeNet

## *A Continuing Report May 2012 through January 2013*

**Editor's Note:** What follows are interviews with Isaac Wilder from October 22 and 25 2012 and January 19, 2013

**COOK Report:** When we last saw each other it was at David Isenberg's Freedom to Connect conference in May, and you were getting ready to attend a number of other conferences. How would you describe the direction in which you were headed when we last met? I am thinking of what you had in mind other than the intention to continue technical development and attend some meetings? When did KC get finalized? Or was it always Kansas City?



**Wilder:** It wasn't always Kansas City, but, by that point, it had been decided. I actually came East to that meeting from Kansas City. I had left New York in mid March and gone back to KC. I had basically been sleeping on my friend's floor for eight months at that point, and I realized what I wanted to do was

going to take a bit longer that I'd originally thought. I suppose the romantic in me though 'we'll, I'll just sleep on the floor, because it's not going to take that long – things were happening so rapidly.' At a certain point I realized I had to get a bed. So, I came back to KC, came East for the meetings, and then went back to Kansas City.

**COOK Report:** Why Kansas City?

**Wilder:** My decision was made on a number of bases. Having roots here was a big factor, the cost of doing business here was a big factor, and wanting to provide a counterpoint to Google

Fiber was a big factor. It essentially came down to Detroit or Kansas City, and it looked as though there were already folks ([The Detroit Digital Justice Coalition](#)) doing excellent work in Detroit along the same lines in Kansas City.

**COOK Report:** Well, you could probably do it with less overhead cost in Kansas City. Was it since you were looking at the Google Fiber environment? In one sense, Google Fiber could be seen as the best of the modern build outs – in another sense, it represents quite a different model than your own.

**Wilder:** That was a part of the idea, certainly. The main thing is that folks are conscious of the issue here in Kansas City, in a way that they're not practically anywhere else. For the past six months or so, really the last three months in earnest, there has been a huge amount of conversation about network infrastructure here. So, here, at least, people are conscious of the fact that there *is* such a thing as a physical



network infrastructure. That's usually the first challenge. If we can start in a place where people already recognize that, it's a leg up, even if it means that we have to coexist with very advanced, privately owned, publicly subsidized networks.

**COOK Report:** So, Google Fiber is emblematic of the accepted way of doing things: big companies do it, and they own the infrastructure, and they own the customers? And you find yourself trying to present an alternative?

**Wilder:** Right.

## The Kansas City Experience

**COOK Report:** In the service of trying to make this accessible to folks outside of Kansas City, can you take the KC experience and recount what that has been like? Tell me about the people and places that are part of your work.

**Wilder:** I think it makes sense to contextualize it a bit within the bigger picture of what the oligopoly players are doing here, and who that effects, and where it is situated physically. We've discussed before how Troost Avenue is really a consummate historical and racial redline. To this day it is a major dividing line between races and economic classes, though there are also pockets of intense poverty in Kansas City, Kansas, and in the northland.

In these areas there is urban decay of the sort that you would find in other post-industrial cities. There's massive unemployment. It's a picture of disenfranchisement.

**COOK Report:** How does this relate to your efforts, and the efforts on the part of Google? I take it that the communities in those areas are underserved. Is Google making an effort to serve them?

**Wilder:** So, that's actually a big part of what I'm driving at. In order to understand the context here, it's important to understand what happened with Google Fiber. The deadline to pre-register for Google service was September 9th, 2012. Google got the City to agree to a build-out determined by demand: there were certain thresholds based on the cost of deployment, and those thresholds had to be met on a per-neighborhood basis in order for Google to come in. [Map below shows registration as on September 1.]

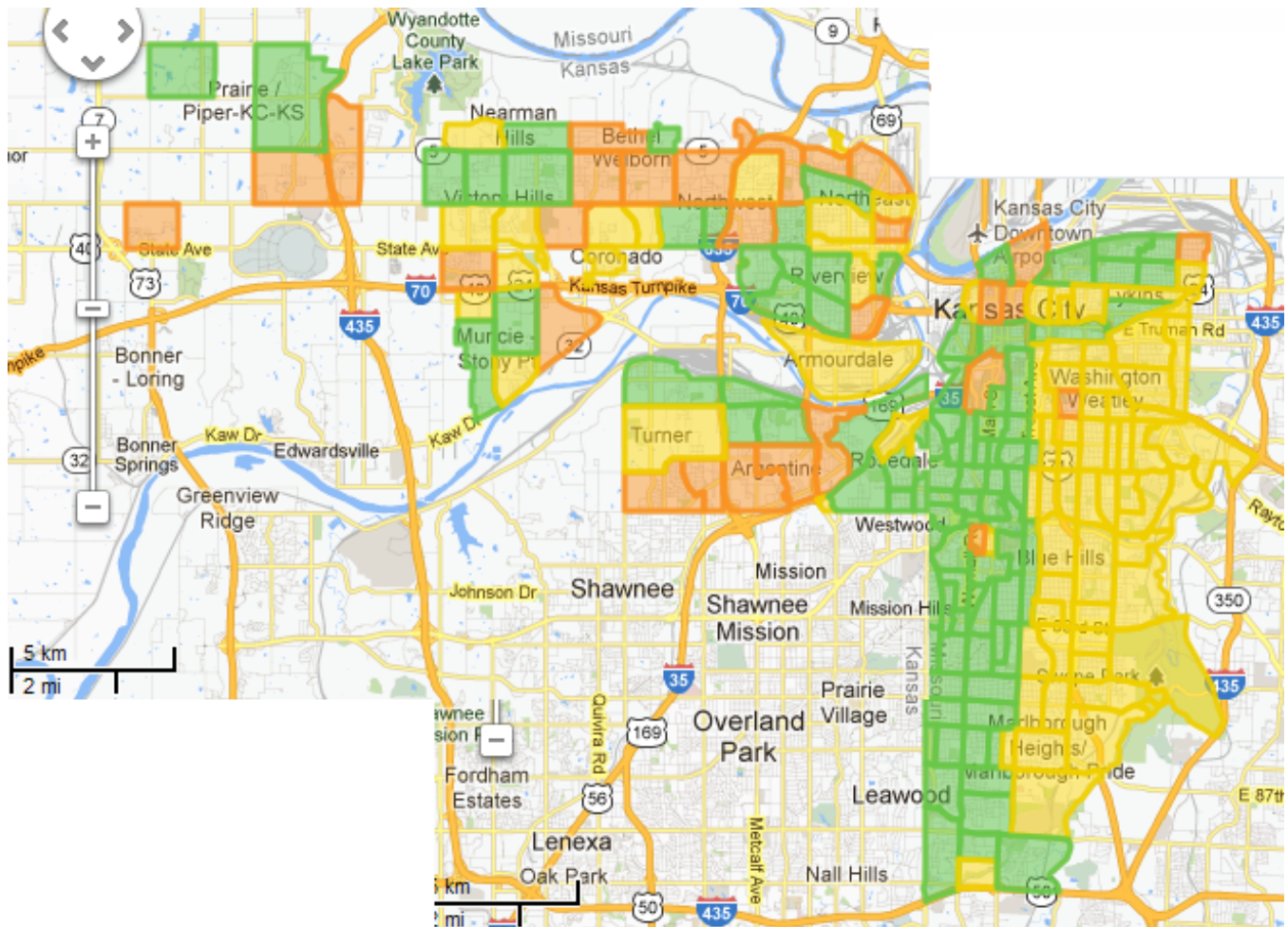

The policies that Google adopted wound up dividing the city exactly along Troost Avenue. If you looked at the map a week before the deadline, to the west of Troost was practically all green (served), and to the east of Troost was practically all red (unserved). Everybody saw that and knew that it looked really bad. In the last ten days of the drive, what happened, was that some folks actually went out in force and paid the registration fees for others, so that the map would not look as divided by race and class. It won't actually help those folks get connected, but it certainly helped with the optics of the situation. The problem remains that folks won't actually be able to pay.

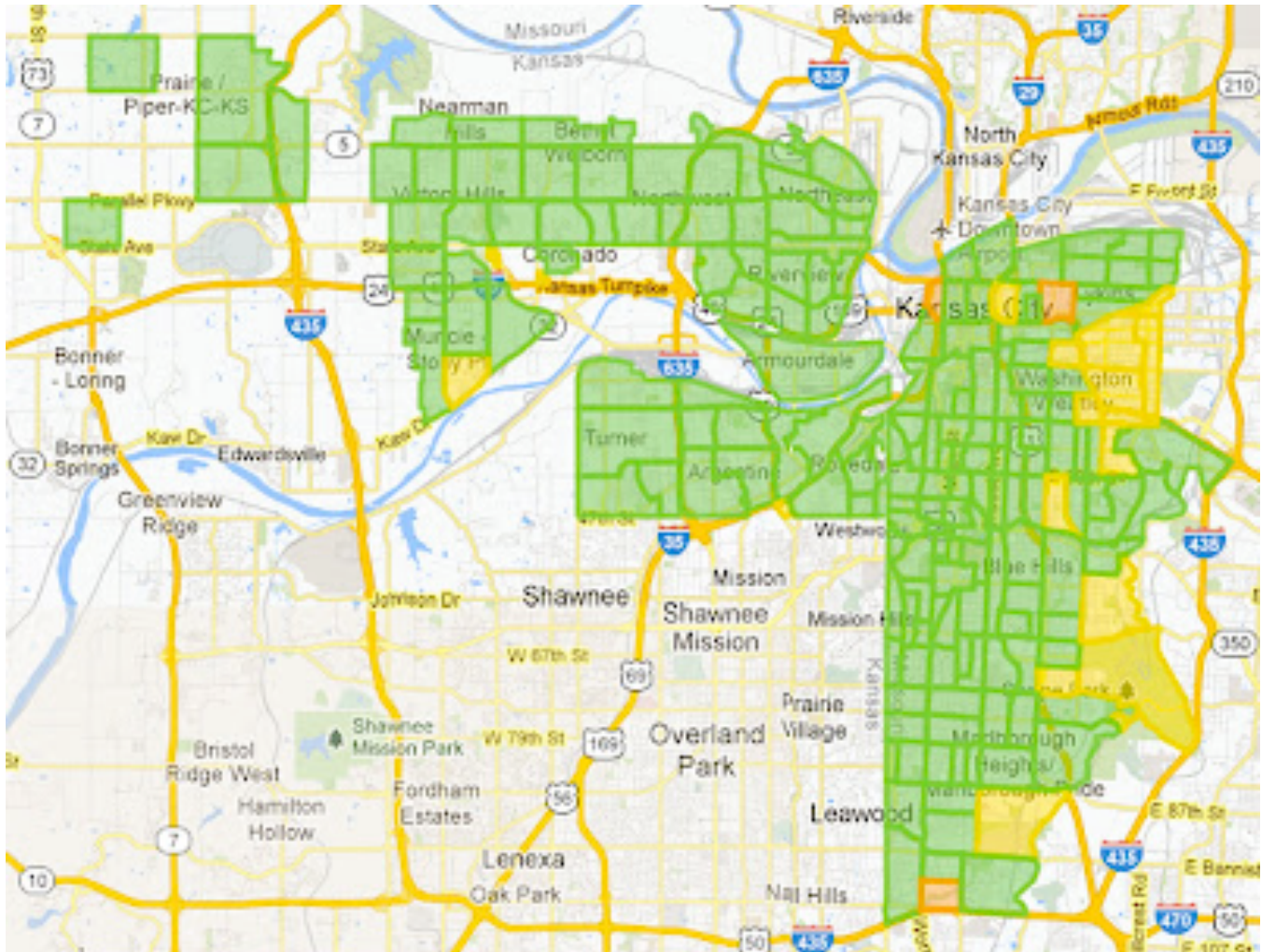

There was a non-profit named **Connecting for Good** [their building is shown at the top of the next page] that formed around the idea of getting Google Fiber brought into some housing projects, and then distributing connectivity via wireless mesh. Google basically told them to get lost. They said that doing it that way was against their terms of service, which, of course, is just a fancy way of saying 'no.' That's when we started to talk, and now we're working with Connecting for Good to provide the bandwidth that Google did not.



**COOK Report:** I know that originally the talk was of doing an open-access network. Do you know what happened to that idea? It seems that maybe Google switched its model when confronted with the reality of trying to bring open access not just to one market, but to many?

**Wilder:** I think that was certainly a part of it. The other notion that some people here appear to have is that the turning point in the development of the network business model occurred when Larry and Sergey brought in Milo Medin to actually realize what some people believe was Google's ambition to get into the access game. Keep in mind, though, that Google never actually came out and said that the network would be open access. In my opinion they certainly let people believe that, but they never actually said it. There were suggestions that shaped people's imaginations, and helped to get massive buy-in from all of these parties, but no explicit promises.

Some folks have postulated that the idea was to keep things vague so that cities would be willing to hand over GIS data by the hard-drive-full. That sort of data is incredibly valuable, and if you can get it by coaxing cities into competing with one another, it's certainly good for growing a network business. It seems possible that before they even got started, Google was able to come away with very detailed GIS and infrastructure data for more than a thousand municipalities.

**COOK Report:** Ouch! One thing that Google has been good at is laying the groundwork for future successes – particularly in the way of getting access to information. Some might put a moral judgment on that, but I suppose it comes down to what one thinks of "capitalism."

**Wilder:** Sure. Depending on what stripe of capitalism we're talking about. There's one way of looking at what Google has done as anti-competitive, which isn't really all that good for markets.

**COOK Report:** Well, it can't be proven one way or another, but it does make sense to realize that the stroke of genius would be to realize all of the GIS data that they could get. It does seem likely that they're using Kansas City as a template of how to approach other cities and do other build outs. To many of us, it became apparent about ten years ago that the telcos were not going to invest in the infrastructure. An argument could be made that, if we are going to have a modern-day telecommunications infrastructure, it looks like Google is about the only way to get there.

**Wilder:** If the only way to get there is via a route that entails total vertical integration of the information environment, it's almost certainly not worth it. We'd be sacrificing our natural and god-given rights for an industrial prowess that wouldn't actually serve to improve the human condition.

**COOK Report:** Sadly - that seems to be happening all over the place. What would an alternative path look like? What is going on in Kansas City as a response?

## But Why Are We Doing This?

**Wilder:** Let me try to use this conversation to explain. We had our first community meeting last Thursday, [**Editor:** mid-October] at the Mutual Musician's Foundation, with the idea of initiating the somewhat sizable project of building a communications cooperative. Understand that such a coop would be independent of the FNF. The FNF is a research, development and facilitation group, but not an operating company in itself. So, last Thursday, about a dozen of us from different social change organizations in Kansas City got together to talk about forming a cooperative. Folks were there from labor, from Occupy, from arts and culture, and from small business.

## The Commons and Community Ownership: Understanding the "Free" in FreeNetwork

**Editor's comment:** This exchange show the difficulty of grasping the commons as infrastructure point of view for those just becoming involved.

**Richard:** But would you be able to reach beyond the coop?

**Isaac:** Sure you would. But you do have to pay. You've got to understand. The "free" here is not free as in free beer, it's free as in freedom.

**Richard:** Wait, what does that mean?

**Isaac:** So, what that means is that there's an economic and political element to what we're doing, which is, we're going to be autonomous and self-reliant, and in so doing reduce our cost in doing this, but also increase our ability to do it regardless of what anybody else says about our activities. And so, in that sense there are costs. And what I mentioned before about Oak Tower, what used to



be the Southwestern Bell Headquarters, and we've found a facility in there where-- there are three or four long distance providers so to speak, Internet long distance providers, that come into that building, it's one of the two main hubs in Kansas City. If we, as a coop, have a facility in that building, and then distribute that connectivity out into the city, we can have cut-rate bandwidth from that facility, plus the ability to communicate internally without even having to go out and through that pipe.

**Richard:** Well, I can understand this concept of "cut-rate" that you're talking about better than I can wrap my mind around this "free" thing you're talking about.

**Michael:** I think what he's talking about, basically, is the coop buys the bandwidth at wholesale. Just like, again, go back to the food coop, if we can buy it in bushels...

**Vickie:** The free part is like we have control. . . .

**COOK Report:** How does the work you're engaged in now relate to the early vision laid out in your writings when you and I first met?

**Wilder:** Well, the idea has evolved quite a bit in the last couple of years. Initially, our understanding was that there wouldn't be a need for any really significant backhaul into the network, because people would be able to utilize existing connections until a sufficient density of neighbor-to-neighbor connections could be achieved. We've actually found that it's necessary to seed the network with the type of low-cost connectivity that you can only be found in a neutral access point. So, while one would certainly hope that folks will connect devices to existing circuits for supplemental connectivity into their home, we're not in a position to advocate or bank on that, due to the legalities of most peoples' contracts with their current service providers.

**COOK Report:** I'd imagine that in the more depressed areas, it's likely that those existing circuits would be marginal, anyways.

**Wilder:** Precisely. So – the idea that we'll



“eat” the network from the inside out does still apply, but in a slightly different way than we had initially thought. Folks connect to the material, neighbor to neighbor network. They will need a source of backhaul, that they will provision cooperatively, in order to benefit from the economies of scale.

**COOK Report:** Isn't that similar to [Brough Turner's business plan](#)?

## What Is Different about the Free Network Architecture?

**Wilder:** I'm not sure that Brough sees the profound potential of the tech to shift the political economy of networks. He doesn't treat the network as a commons. And in any case, NetBlazr isn't at all concerned with the logical infrastructure necessary to tie it all together. Folks could join the free network from anywhere. That's what we mean when we say the plan is to eat the network from the inside out. Just connect a FreedomBox to any existing circuit, and it can grow from there.

**COOK Report:** Explain a bit about the tunneling. It would allow the free network in Kansas City to connect to the free network in Austin?

**Wilder:** Well, that's part of it. One element is that individual free networks would be connected to each other through persistent site-to-site tunnels from FreedomLink to FreedomLink. [**Editor:** the FreedomLink is the more powerful line of sight multi gigahertz connection from regional exchange points to local FreedomTowers.] The connection would run from tower to link and exit at the connected link to tower in another city. There is also another consideration: that anyone, anywhere in the world could tunnel to the nearest FreedomLink as an entry point into the network. They could tunnel in, get an address, and use that address for end-to-end encrypted communications.

In essence, somebody running a FreedomBox (or even just their own machine, if they're adventurous) could install a VPN client that would allow them to set up an encrypted connection with the FreedomLink. That way they can have a public IP address. The FreedomLink would announce their address out to the Internet, and so they'd be able use their IP address as it was intended – as a globally unique part of the routing space on the Internet. This would enable all kinds of neat applications that are either blocked or made difficult by Network Address Translation.

## The Co-operative: Legal and Physical Structures

**COOK Report:** So, you're going to start by building a cooperative – what does that entail in the next six months to a year?

**Wilder:** Over the next six months, what we'll do is partner with Connecting for Good in the Rosedale neighborhood, and try to get the kinks worked out in terms of technology and

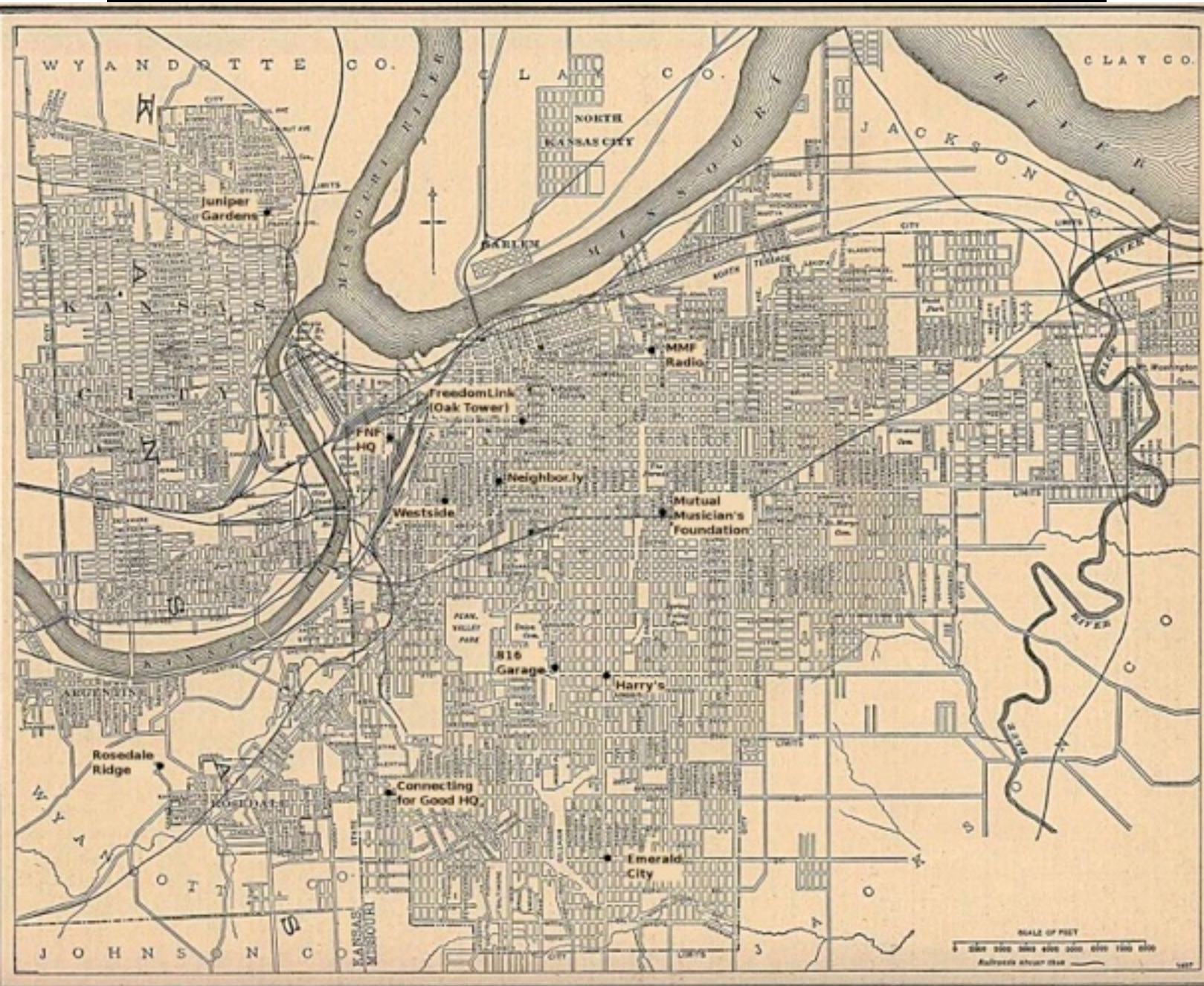

Note that the map above shows the physical location of the organizations involved in the services and infrastructure of the Kansas City freenet that Isaacs group is building.. Rosedale Ridge is bottom left and the FreedomLink at the Oak Tower exchange is top left Most of the organizations shown on this map are discussed n the text hat follows.

deployment. We'll also figure out what the corporate structure for the coop should look like. In particular, our focus will be making sure that the network is owned and governed by its constituents. We're trying to come up with a set of bylaws that ensure mutual benefit and cooperation in perpetuity.

**COOK Report:** And this is a set of bylaws that the Rosedale network could adopt, or that a network elsewhere could eventually adopt?

**Wilder:** Yes. Exactly.

**COOK Report:** Give me a sense of the actual layout of the Rosedale network.

**Wilder:** Rosedale Ridge is 3.7 Miles from the [FreedomLink](#). They're up high enough, and the lines are right such that, if we can clear the trees, we should have a good shot back to the FreedomLink. What it will involve is likely a single point-to-point link at 3.65 GHz between the Freedomlink and the Rosedale [FreedomTower](#), with the potential for two bonded links if the throughput on one isn't sufficient. The FreedomTower would anchor a mesh network covering a housing development of 250 units, and potentially the neighborhood below.

**COOK Report:** So then, this doesn't depend on your finishing your suite of tools? What is the timeline?

**Wilder:** No. It doesn't depend on a finished stack. It's using existing hardware and software tools to do what hundreds of internet service providers have done, but doing it with an eye towards empowering people. We want to help people who need access to serve themselves.



**COOK Report:** And what is the role of [Connecting for Good](#) in all this?

**Wilder:** They'll be running education programs, as well as collecting and distributing computer hardware at low cost. We're sharing responsibility for the network in the short term as we figure out the best way to put it under

its participant's control.

**COOK Report** How then, are you reaching out to the communities that will participate?

**Wilder:** Well, a lot of the outreach for the Rosedale piece has been done by Connecting for Good. We've focused our efforts more on the east side. One of our biggest allies has been the [Mutual Musician's Foundation](#), which was formed in the thirties as a protective union for black jazz

musicians. Through our friends there we've connected with a number of other groups, and have started hosting community meetings. Our approach is just: hey, let's work together to solve this problem, and people seem very open to the idea. They're skeptical of the providers like Google Fiber and AT&T- they know that the point of those outfits is to make money off of them. Any service costs money. Nothing is truly free. But we believe that our service can be delivered for a lot less and help to keep the money needed in the local economy.

**COOK Report:** So, it's you and who else on the ground?

**Wilder:** Well, my colleague Tyrone relocated to Kansas City. He's a friend from my college days, and was indispensable to our actions in New York City during the Occupy Wall street action. He has a background in history and helps a great deal with administration. We've had a number of local contributors on the technical side come on board, but on the organizing side it's mostly me and Tyrone, and the folks from Connecting for Good.



**The Rosedale Ridge Apartment complex**

**COOK Report:** So, I guess you need a few more months working with groups to figure out where your first towers will go?

**Wilder:** Well, there are a limited number of places that make good sense, given the geography of Kansas City. So, we're approaching those folks that have high ground to see if they'd like to put something up. To give you an example, we've been working with some folks from Occupy Kansas City to repair the roof on an old building at 31st and Troost, which is just about the highest point in the city. Hopefully in exchange for that, we'll get some space there, and be able to put some radios on the roof.

**COOK Report:** So you'd put a FreedomTower there?

**Wilder:** Yes. Exactly. And from there it would be hop-by-hop. We've been working with an artist collective and housing initiative called Emerald City that's a bit further to the south, in an area of town called Manheim. They're putting up a radio mast, and we ought to be able to put some radios on there.

### Wireless mesh network and freedomTower antenna and gear at Rosedale Ridge

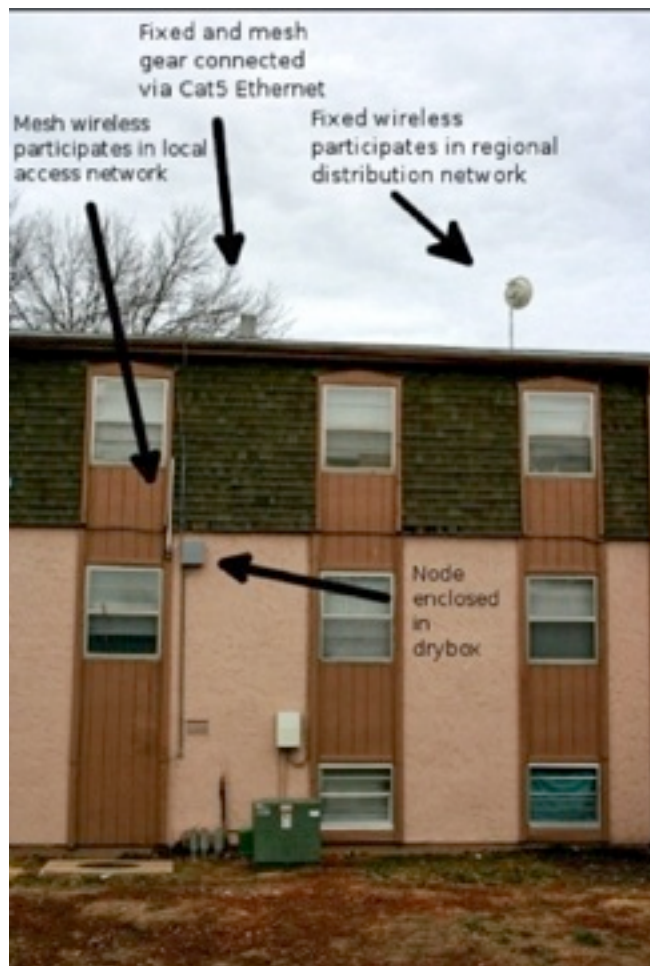

**COOK Report:** So are there different classes of FreedomTowers – one variety for key locations, and one for less critical ones? And one about nodes and boxes? How do they fit in and what is the different between them?

**Wilder:** As far as the tower question, you're right that there would likely be different varieties with more or less power or different types of antennas, depending on the situation. ***The important thing to take away is that the FreedomTower serves as a bridge between the regional point-to-point backbone network and the neighborhood mobile ad-hoc network.*** By definition, FreedomTowers participate in the point to point network – whether they communicate with the FreedomLink directly, or with another, intermediary FreedomTower isn't hugely important. What is key is that on the one hand they are communicating with other regional network devices, and on the other hand they are **also** communicating with the nodes of the neighborhood network.

**COOK Report:** Okay, and what is the difference between the node and the box?

**Wilder:** Right. The node is a radio device. It would behave like a modem. So, [FreedomNodes](#) are radio components, and their role is to build the material network. The [FreedomBox](#) is a small form server running a suite of logical tools that allow people to communicate with end-to-end encryption, and to take advantage of the local connectivity provided by the nodes.

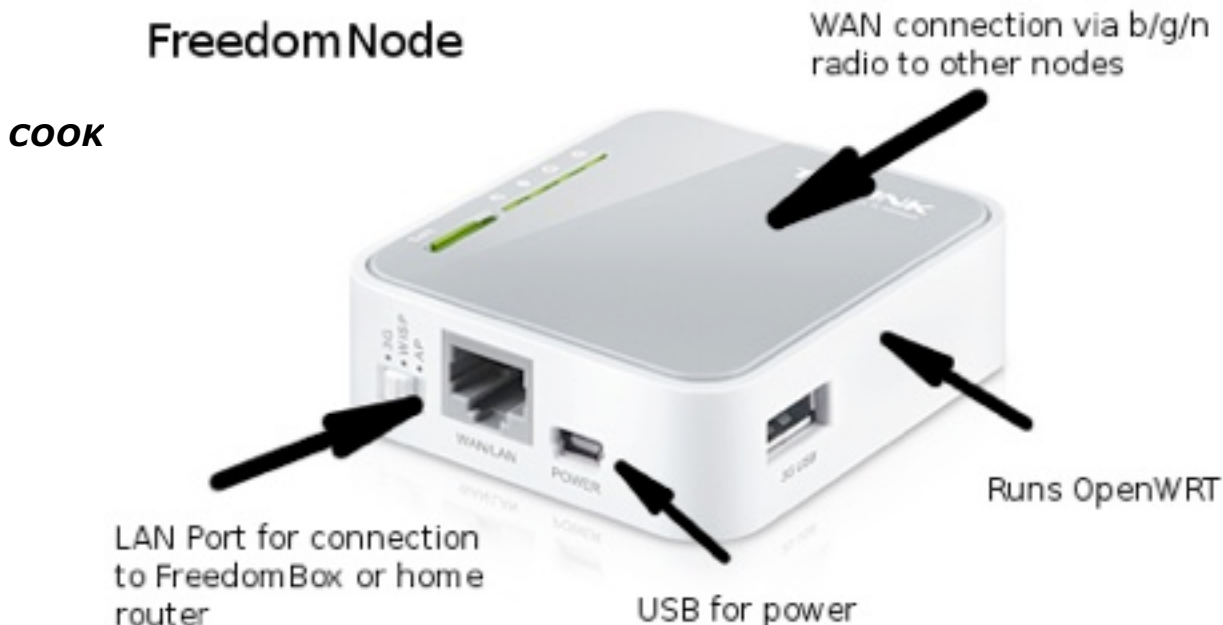

**Report:** I get the sense that the FreedomBox would be an add-on to an existing computer – is that right?

**Wilder:** Not exactly. You're right that you could use whatever computer you like - even your own personal machine. The FreedomBox, plain and simple, is a server - a low power server. It doesn't necessarily have a radio. It doesn't have to participate in a mesh network. You would access it by opening up your laptop and typing 'myfreedombox' into an address bar, and an interface would come up that provides access to the services running on that device.

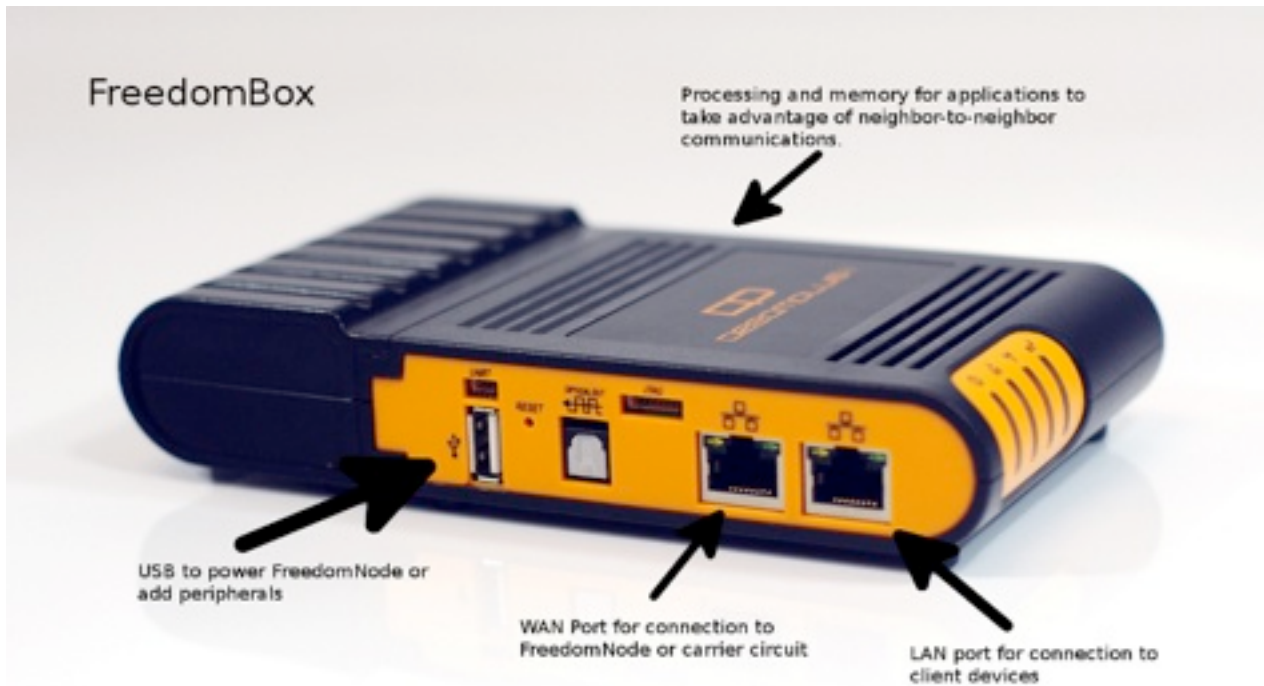

It would either be connected to your router, or replace your router. So, in the simplest full setup, you'd have a FreedomNode acting as a modem, and a FreedomBox as your router - you'd have connectivity via the node, and you could access the services running on the FreedomBox via a web interface.

**COOK Report:** So the freedomBox would replace your old Linksys router? But it would have additional software capability?

**Wilder:** Right.

**COOK Report:** I see. So will there be a device that combines the function of the FreedomNode and the FreedomBox?

**Wilder:** There certainly could be. I think it makes sense to have them available in a modular way for two reasons: it allows anybody to plug a FreedomBox into an existing circuit and participate in the logical aspects of the free network, and on the other hand,



you could have just a FreedomNode, and have the same sort of Internet connection that's provided by an ISP, except cheaper. Ideally, folks would do both. The functions are distinct: the FreedomNode is concerned with things up to layer 4, and the FreedomBox is concerned with things above that.

**COOK Report:** So not everybody would necessarily need a box?

**Wilder:** Exactly. But the reason why the box is important is that it would allow for the proliferation of the network to physically disparate places, that can then grow together because they have a unifying logical layer. Far-flung boxes would have to tunnel in to get a public IP address, while nodes would hand them out directly, but either way end nodes would have their own address for communications. I should say though, that we're not as focused on the FreedomBox as the node, the tower and the link. [FreedomBox](#) has its own foundation that is driving that project. We're staying focused on the connectivity issue.

**COOK Report:** And you're watching them to make sure that you can plug their product into your connectivity mesh easily?

**Wilder:** That's exactly right.

**COOK Report:** Can you say what remains for them to do before they've got a usable product?

**Wilder:** They need to take a web interface that exists, and make it so that instead of being a mock up, it actually hooks into the system in a meaningful way. Teaching the interface and underlying software to "push" all of the right buttons in Debian is not a small task. There's a lot of logic that has to go in, in order to do it right: system administration is hard, and we're basically talking about building a server that both administers itself, and is self-healing.

**COOK Report:** As an architectural design and development task, is this something that you're working on spreading out?

**Wilder:** We're trying to distribute the workload, but it has proven hard to find people that are willing to give their time and energy to a project that seems so big in its scope. It's like we're asking people to participate in a project to build a moon colony. They say it's out of reach. We do have people in a number of places, but we need the right infrastructure to collaborate effectively. That's actually what we've been working on more than anything else, by far: the infrastructure for that distributed workflow. *Companies can take that sort of stuff for granted, because they have large budgets with which to provision it, but for a free software project, it's much more difficult to take on a project of this scope.*

**COOK Report:** It sounds like you're saying that you don't really have a sufficient off-the-shelf tool kit for distributed development? [**Editor's note:** Isaac suggested around the first of December this very big network in Spain called guifi.net as readers have seen by now I did and my world will never be the same. As proof of concept of the feasibility of what Isaac is doing guifi.net astounds! Note finally that on February 1 the two joined forces.]

**Wilder:** That's right. Not at the scale we're attempting. The other thing to understand is that what virtually any other project would do is use infrastructure provided by a number of big enterprises. Instead of just signing up for accounts with Google and [Github](#), we've decided to take matters into our own hands, and to maintain our own tools.

**COOK Report:** So, on the one hand you're developing the suite of appliances for building replicable, horizontal networks, and only the other hand you've developing a rack of tools that are Internet accessible to developers, so that they could log in and use them to work on improving the appliances?

## The FreedomCenter

**Wilder:** That's right. That suite of tools we've branded FreedomCenter. The idea is to offer resources, space, and tools for likeminded projects. In joining with guifi.net we're trying to lay the foundation for what we both hope will be a global community.

As with much of our work, the technology is not unprecedented. It is the intended use of the technology, rather than the technology itself that is far more central to understanding our mission. In addition to supporting all of the FNF's back office and web applications, FreedomCenter will provide for continuous compilation and rolling release of software and firmware, a self-service virtualized network testbed, and a multi-tenant runtime and radio lab.

**COOK Report:** Tell me what the various components do.

**Wilder:** Sure.

**Stor01 and Stor02**, the systems at the top of the rack, represent our storage cluster. Each systems runs [FreeNAS](#), which is a storage appliance operating system that leverages [Zetabyte File System](#). This system enables storage snapshots, automatic deduplication of data, replication of datasets, and presents all volumes to the network as NFS shares.

Our Production environment (internal and external web applications) live on Stor01 and are replicated to Stor02. Our Development environment lives on Stor02 and is replicated to Stor01. This provides for maximum IO, reduces disk contention, and ensures a near-line backup of all mission-critical data.

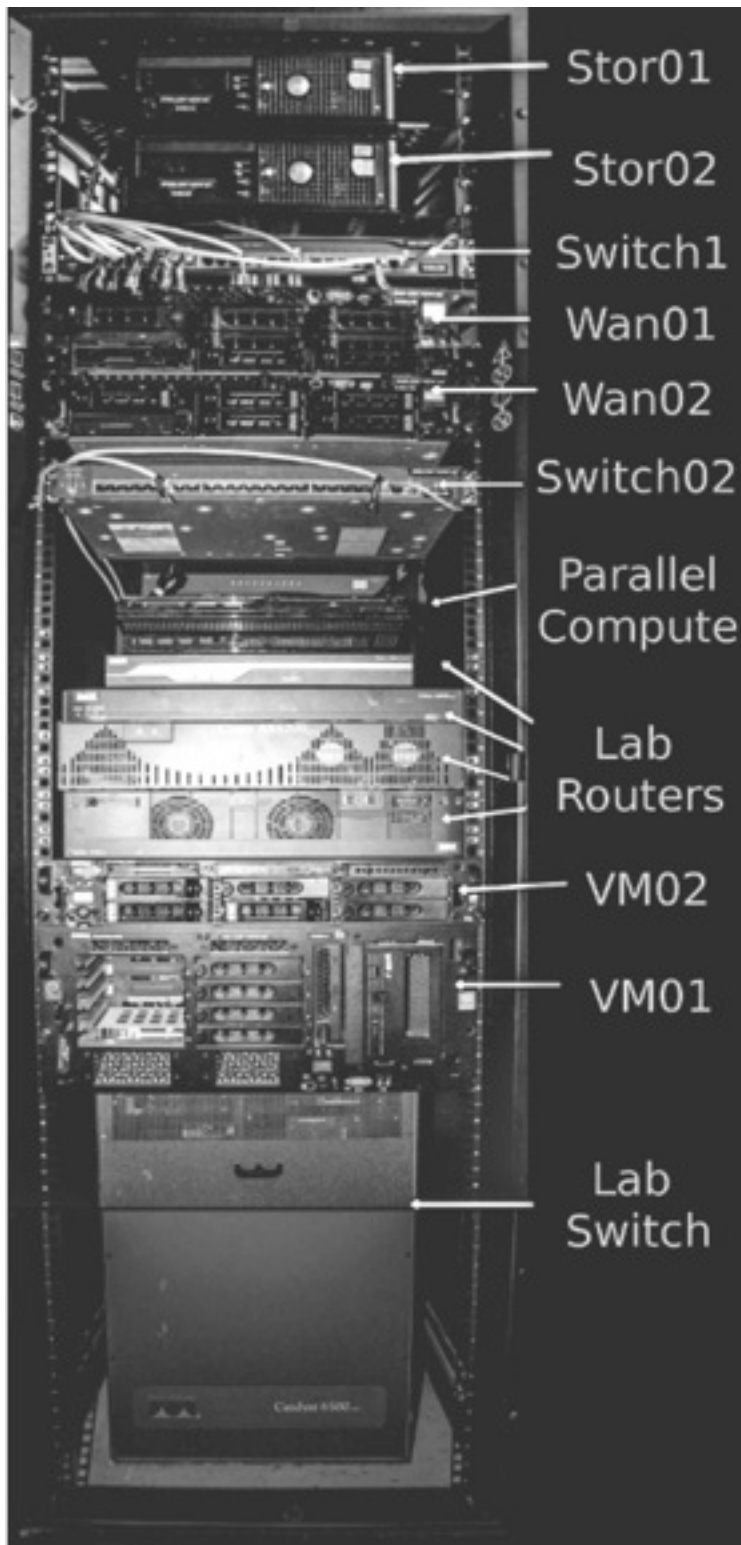

**Switch01 and Switch02** are Fast Ethernet switches. In the configuration shown in the image, Switch01 is in operation, and Switch02 is a warm standby. We are presently implementing a configuration in which the switches form a redundant fabric, leveraging Per-VLAN [Spanning Tree Protocol](#). These switches provide for (V)LAN connectivity for all of the other devices pictured.

**Wan01 and Wan02** are our edge routers, connected to our upstream providers on one side, and to the LAN on the other. They are responsible for Firewalling, Routing, serving DHCP to the LANs, and acting as VPN concentrators for remote access. They are connect directly to each other in a High Availability configuration, so that if the primary fails, the secondary takes over automatically.

[The Parallel Compute box](#) is in fact a PlayStation 3, whose cell processor provides extremely well parallelized computation power. This is particularly useful in the batch signal processing workload of Software Defined Radio, and for running large scale simulation that leverage parallelized algorithms.

The **Lab Routers** are various pieces of common Cisco routing and firewalling gear, intended for use in a remote-access network sandbox. The

idea is that folks can schedule a time to use the lab to get hands on experience with various elements of core networking. This would be extremely useful to folks that are looking to earn network certifications, or generally increase their network chops.

**VM01 and VM02** are our virtualization servers - at any given time, there are several

dozen virtual servers running on these boxes. The boxes run Ubuntu 12.04 on the bare metal, and use Linux Containers for virtualization. Container workload is load balanced across the machines, but in general, core infrastructure (DNS, MySQL Server, Mail, LAMP and Ruby applications) run on VM02 and Development infrastructure runs on VM01.

**The Lab Switch** is a [Cisco 6509](#), which is, similar to the Lab Routers, intended for use in experimentation and learning. Our goal is to offer these resources to the public in an effort to democratize networking knowledge, and get more people to a point where they are able to build and contribute to community network commons.

## Envisioning Emergence

### Phase 1

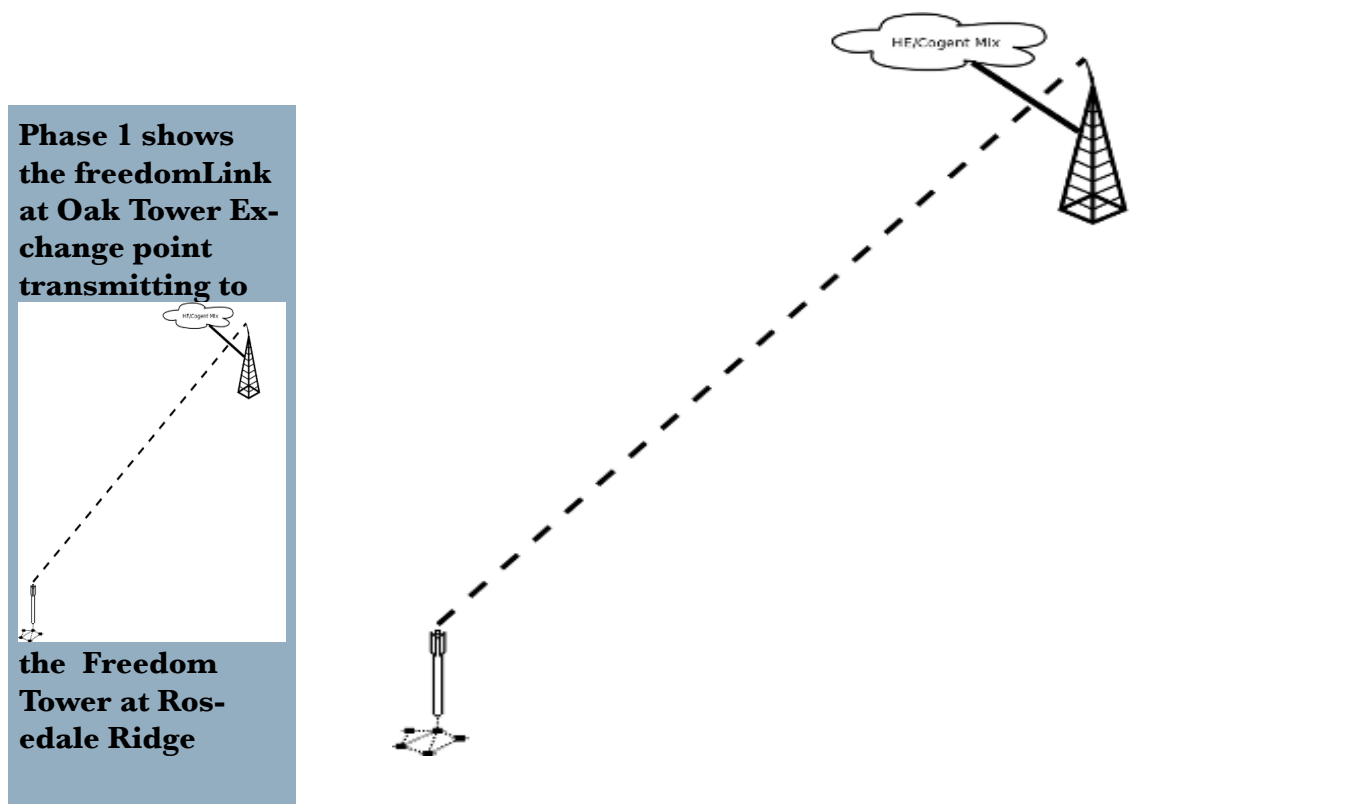

What follows is not a prescriptive vision. It is an exploration of how some portions of a global free network might emerge. It is not intended to explain the design of the relevant tools and technologies – but rather to augment one's understanding of what these tools are designed to *do*. **This particular depiction is a to-scale depiction of our projected growth curve in Kansas City.**

The network emerges as a modest internet co-op – it is not particularly groundbreaking in its technological functioning, though there is a healthy amount of systems engineering and integration that goes into its construction. The FreedomLink is situated in a building with major network POPs, such that it can take advantage of wholesale bandwidth at

competitive prices. A housing complex, small business, or community center hosts a FreedomTower with a Line-of-Site microwave link to the Link. A few well-placed FreedomNodes help distribute connectivity to the surrounding complex. Publicly routable IPv6 addresses are delegated from the Link to the Tower to the Nodes to client devices. Because the network does an end-run around for-profit middle mile and last mile networks, it is able to offer high-speed connectivity to its participants at a small fraction of the retail cost.

In this particular case, the FreedomLink is in [Oak Tower](#), downtown, and the first FreedomTower is at Rosedale Ridge, in Kansas City, Kansas. This phase of emergence was completed in December 2012.

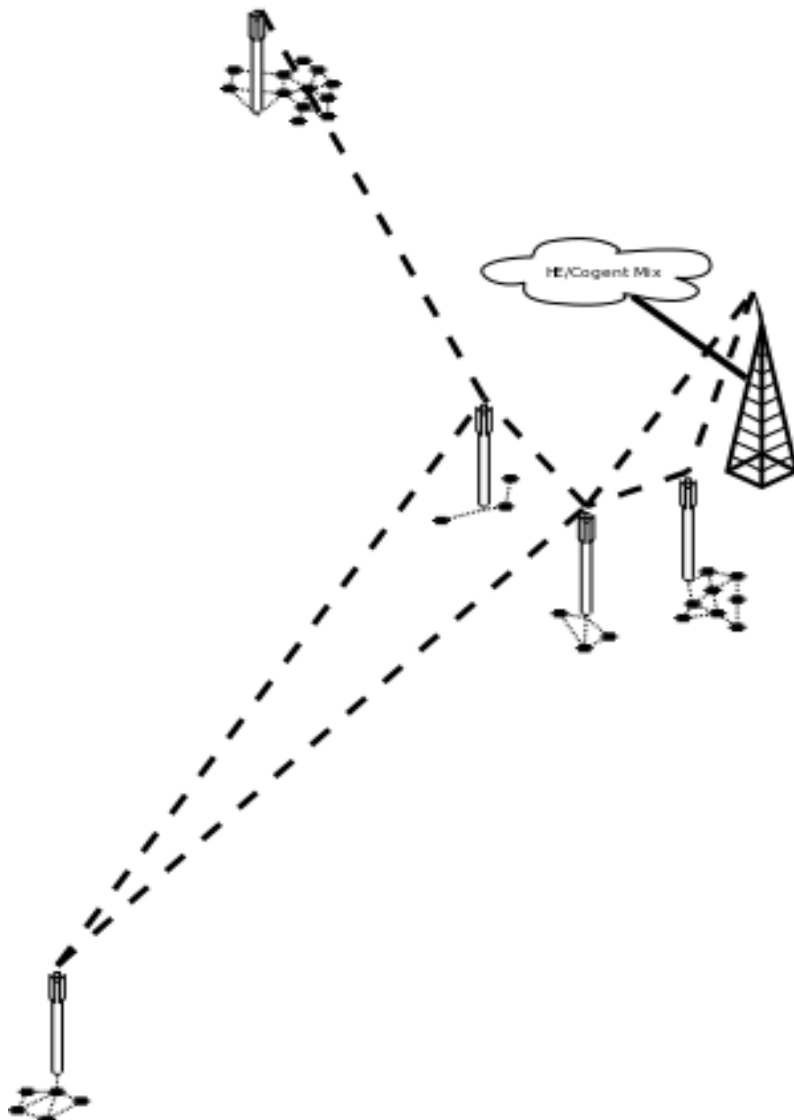

## Phase 2

The scale of a neighborhood access network is limited by geographic proximity and routing overhead. Additional anchor institutions are compelled to join the regional distribution network because it affords an opportunity to save on connectivity costs while providing a service for their community. As additional FreedomTowers come online, the process increases the robustness of the distribution network.

The commons-based model of free networking dictates that there is no single economic formula for provisioning infrastructure. Instead, each site is free to choose their own model. Where some neighborhood networks might be provisioned by non-profits

or public sector actors, others may be funded through a neighborhood association, a civic campaign, or private capital.

As density increases, and the number of locations willing to collocate a tower increases, better lines of sight and more robust network topologies becomes possible. Longer links

are replaced with shorter ones, increasing capacity. Private interests can participate in the network, the only stipulation being that they cannot treat their network segments as their private property. Any participant is free to reclaim any equipment at any time, but as long as the equipment is participating in the free network, it must be open to all on equal terms.

In real terms, we expect of the next three months to see the [Westside Project](#) and [Juniper Gardens](#) come online, funded by a non-profit in conjunction with the KCK housing authority, the headquarters of the FNF, funded by a private corporation, and the Crossroads mesh, anchored by [neighbor.ly](#), and funded through a mix of crowdfunding and neighborhood association dues.

The network continues to grow, as neighbors and neighborhoods cooperate to achieve mutual benefit. Individuals are able to buy nodes ready-made and have them installed for a modest fee.

### Phase 3

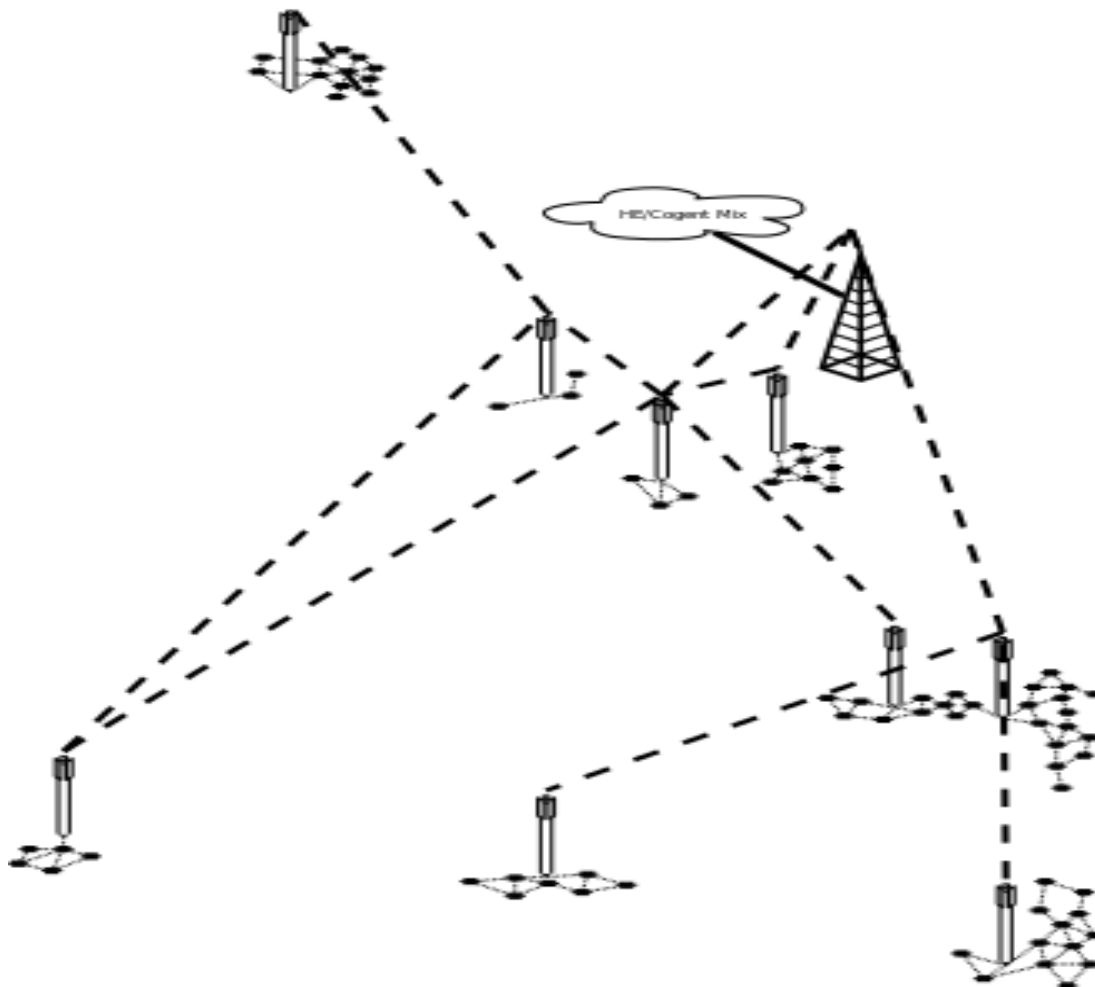

***Because the network is open for all to use, those with a marginal connection or just outside the range of an access network have an incentive to help grow the network into their geographic proximity. The network landing page can be configured to display the sponsors of the various pieces of infrastructure currently in use by a participant, providing an opportunity to strengthen the civic spirit of blocks and neighborhoods.***

A single neighborhood network can have multiple towers, as shown at right. This provides another layer of robustness to the architecture. In this case, Harry's and the 816 Garage are close enough that it makes sense to have a single access network between the two. Because they both offer excellent (and different) lines of site, it makes sense to have multiple towers so nearby.

We expect the four new towers in this phase to be built over the next six months. The 816 Garage and Harry's towers will be funded through the collective effort of voluntary associations ([The 816 Collective](#) and Industrial Workers of the World, respectively), the Emerald City tower will be funded through a neighborhood fund-raising project, and the Connecting for Good tower will be funded by a non-profit with corporate sponsors.

## Phase 4

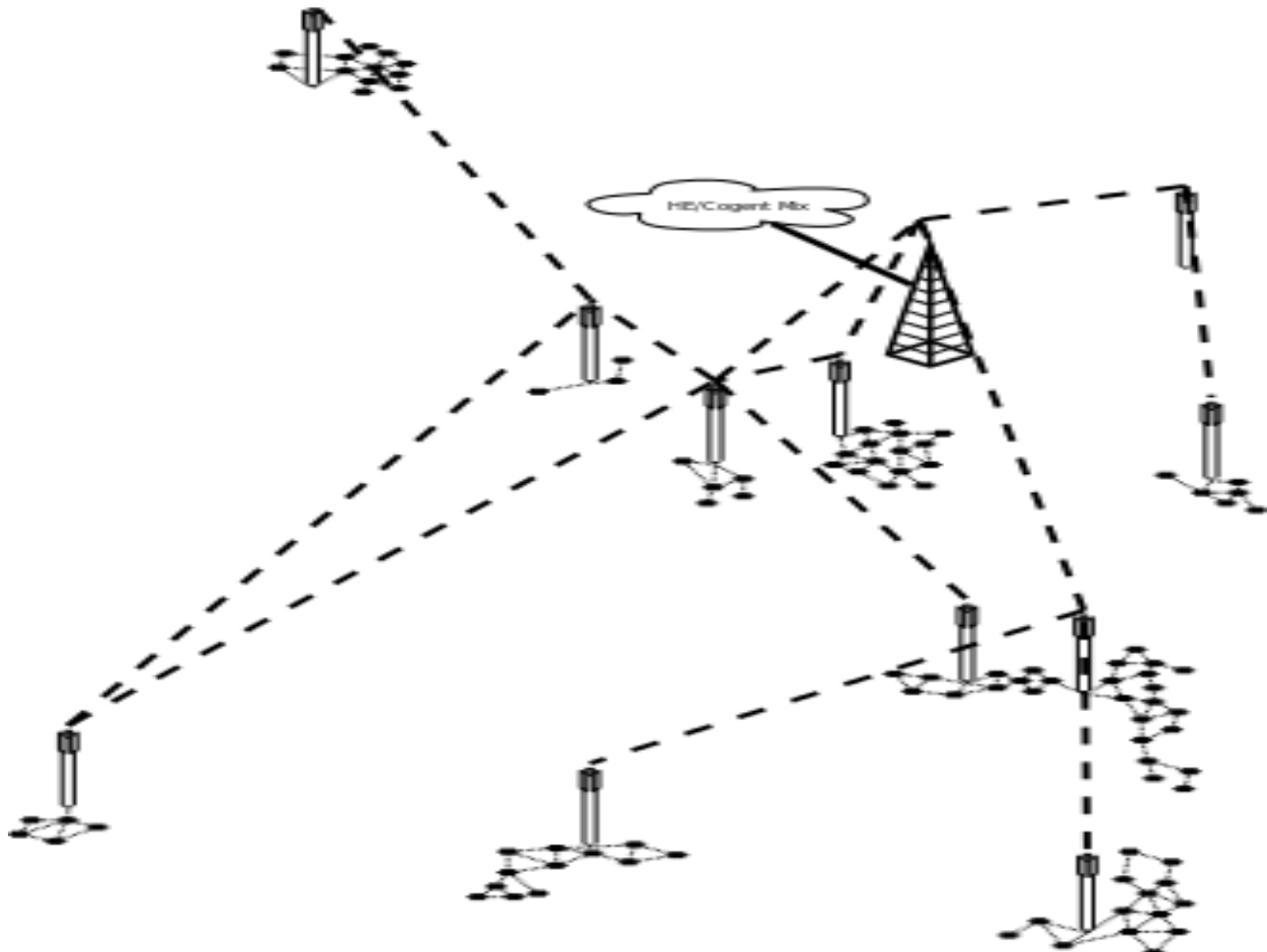

For the sake of simplicity and intelligibility, I have only depicted here the emergence of a single material subsystem – ignoring the parallel development of other regional cooperatives, or the logical infrastructure to tie them together. The intent is to give the reader some idea of how such a system could come about in practice.

Our contention is that increasingly large and more numerous material subsystems will grow inside of the Internet. Free networks will begin to eat the network from the inside out. Carriers will either compete for the business of backhauling neighborhood access networks, or be cut out of the picture by a material end-run.

FreedomLinks will provide the logical infrastructure for federating regional networks – this means global routability for end nodes, and a high degree of identifier portability. They will also act as VPN concentrators, allowing anyone with any type of connectivity to participate in the network on a logical basis, until such time as they are able to do so on a material basis. Sites that tunnel into the overall logical network can anchor a material network of their own, that will eventually grow to meet, and fuse with, a larger network.

***As regional cooperatives grow, the economies of scale will only continue to improve the value of the growing commons. Just as neighbors and neighborhoods are able to organize infrastructure provisioning for mutual benefit, regions will be eventually able to buy or build their own transit capacity. Everything interconnected under the understanding that we all give, and we all receive in turn – a communications commons, built by all, maintained by all, and for the good of all.***

## Making Headway

**COOK Report:** Now that we have gone from the conversations of late October, what are the highlights in November and December and so far in January? Technical, social, political, economic, how would you characterize some of the events?

**Wilder:** Sure. So I think the most significant thing to have happened is that the Rosedale Ridge project, which was in a planning stage when we last spoke is now live. It's providing connectivity to about 200 families, only one of which, I believe, had connectivity in their home before the network was built. So it's quite a difference in the lives of these couple hundred families.

**COOK Report:** How was it was executed?

**Wilder:** Well, we were able to negotiate a deal for backhaul at Oak Tower, and basically build the first production FreedomLink, build one FreedomTower at Rosedale Ridge, with a point-to-point microwave link between the link and the tower that delivers roughly forty megabits of bandwidth to the site, where it is distributed via a mesh network.



**COOK Report:** So what was the cost of getting this done? How did the economics work out?

**Wilder:** Sure. To colocate the FreedomLink consisting of a core router and radio dish, and pay for the backhaul we negotiated a rate of \$125/month, which compares quite favorably with the \$350/month that Time Warner Cable wanted for a similar amount of bandwidth. It would have been more, but we were able to work out a deal to locate our radios inside the data center, rather than on the roof, saving a couple hundreds dollars per month. There's a slight performance hit, a few dB, but it works! The cost for the point-to-point gear was a little less than \$500, and then the mesh gear was donated, but had it been bought retail, it probably would have come in around \$400.

**COOK Report:** How many nodes are there in the mesh network?

**Wilder:** There are four repeaters in the complex, and we're thinking about installing four more to increase the coverage. Everybody has at least a marginal link right now, but there are some people on the periphery that don't have a very reliable link to the network.

**COOK Report:** So each repeater costs about \$100?

**Wilder:** Maybe slightly north of there. Do understand that because the gear was donated, it's not what we would ordinarily want to use. It's propriety gear from Meraki, and it is actually programmed to become useless in about two years from now. So at that point we'll want to go in and replace the repeaters with ones that don't limit us as much.

**COOK Report:** Lord! I'd heard about Meraki, but I never heard that.

**Wilder:** Yeah. It's pretty crazy when you think about it. In any case, though, it's sort of a temporary solution to get us off the ground, not to mention that there seems to be some merit in the idea of repurposing or reusing technology that would otherwise end up in a landfill. So, those nodes cost maybe \$100, \$125 a piece. The new Meraki outdoor gear is more expensive, it costs about \$1000 per unit, though the units are more powerful. Of course, you could homebrew something even more effective for around \$500. That's something that the FabFi group has done a marvelous job of making more feasible.

**COOK Report:** And not self-destructing, right?

**Wilder:** That's right.

**COOK Report:** Okay, what has the reaction been from the users?

**Wilder:** It has been incredibly positive. The Kansas City, Kansas school district sends home laptops with all of their high school kids every day, and I think thirty or forty of

those have logged on. All in all, several hundred devices have logged on – Android devices, to a large extent. In general, the population there at Rosedale has been really, really enthralled with the network. Because Rosedale Ridge is up on top of a big hill, and there's poor bus service, it has always had trouble leasing out their apartments. Since the installation of the network, they have leased every apartment in the complex.

**COOK Report:** That makes good sense. I am sure that the complex developer is very pleased. What interaction have you had with them?



**Wilder:** We needed their permission to go up and do the install, and they have actually agreed to pick up the bandwidth costs going forward.

**COOK Report:** Good. Now let's turn to education. The school district distributes laptops, but many of the kids take them home and can't get on the Internet? Is that common?

**Wilder:** In economically depressed areas, it's very very common for one, maybe two families in a square block, or in a big housing complex to have connectivity. In fact, just last week,

**Rewards of a job well done -- Isaac stands by the FreedomLink dish antenna in the Oak Tower building that formerly was the headquarters for South Western Bell in Kansas City (one of the seven baby Bells). The dish is connected to the global Internet by way of a router a few feet behind where Isaac stands. The radio connects to the FreedomTower at Rosedale Ridge.**

**there was an incident where some cops were driving by a school and they saw a crowd of kids, and so they called the principle, saying "Hey, I think something is going on, you'd better get down here." When the principle got there, it turns out the that the kids were sitting out in the cold so that they could pick up the wifi and do their homework.** [Editor's Note: I have bolded this because it is called out in

the Conclusion below (p. 145) as one of the best examples of unmet need.]



On December 22, 2012, after two days of training, Dan presents a free refurbished laptop to one of our five Ambassadors at Rosedale Ridge. They will use them to demonstrate to other residents what can be done online and encourage many more to attend the digital life skills sessions.

**COOK Report:** Besides the students, do folks have computers? Do they have the skills to actually use the network?

**Wilder:** For those that don't, we have partnered with a couple of local non-profits, [Connecting for Good](#) and the [Urban Youth Center](#), who are running a digital literacy program, and selling subsidized, very low cost laptops. We've done a pilot of the education program with the first group of five residents, who we call 'ambassadors' - they're charged with helping others get on and taking advantage of the network.

There was much media coverage of the Rosedale Ridge connection. The story from the *Kansas City Star* is [here](#).

**COOK Report:** So, I know that the Rosedale project was covered in the local media. Has anything come of that coverage?

**Wilder:** Definitely. There has been a huge surge of interest. Right now we're talking with two more housing complexes that are interested in working with us, and with some folks in the Crossroads neighborhood. There's really been a surge of interest in DIY connectivity – where before people didn't even realize this was possible, now they can see it, and very many of them are interested getting involved.

**COOK Report:** Sounds like it has a pretty good impact.

**Wilder:** Yes. Definitely. It's allowed us to strengthen our cooperation with Connecting for Good. I now sit on their Board of Directors, and they've agreed to act as our fiscal sponsor until such time as the IRS responds to our application for tax-exempt status. So there's all that, we're planning more cooperation with them, and are very pleased to see a free network growing in Kansas City, but there's actually been a lot more than that going on.

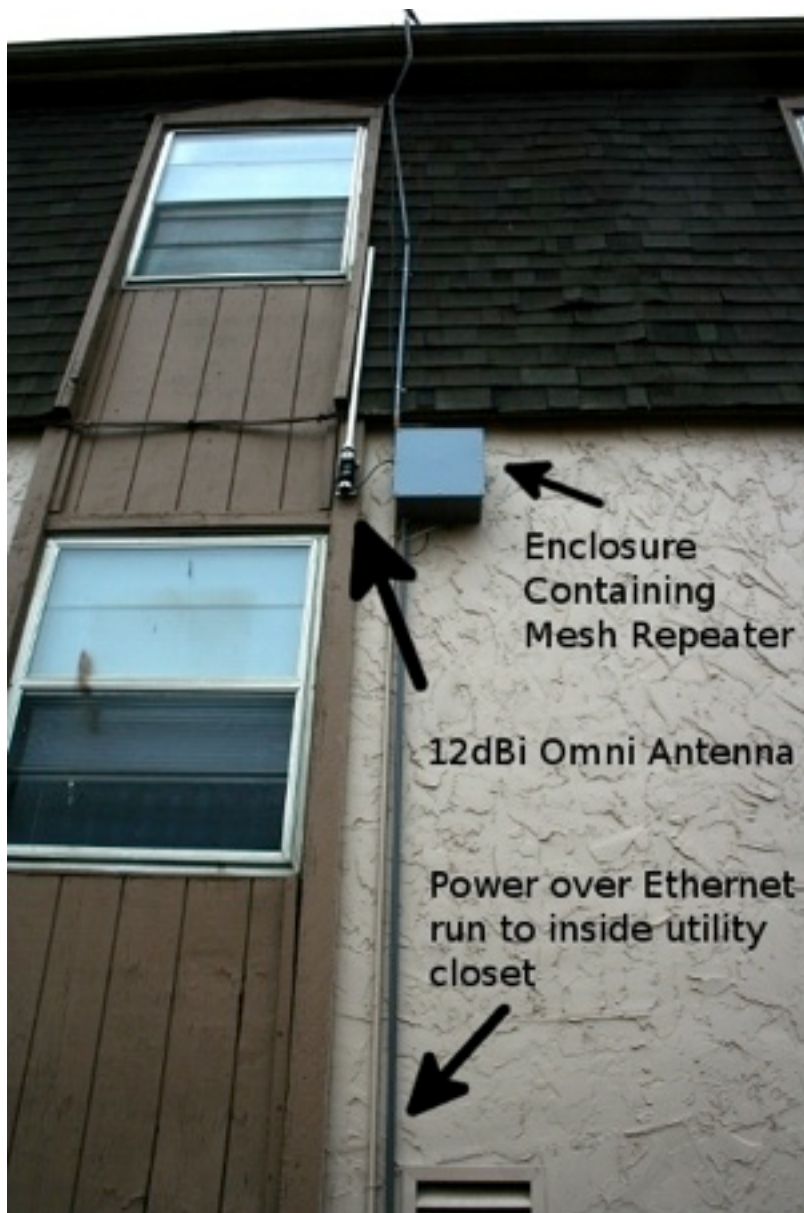

**COOK Report:** Say more. (Note that the picture below is a closeup of one of the Rosedale Ridge nodes. Page 122 shows whole building.)

**Wilder:** Work has continued on FreedomCenter in a really productive way. Something that I imagine you'll be pleased to hear about is that we've taken a piece of software developed by Guifi and a couple of the other European Community Networks, called [CONFINE](#), and are using it to automate a lot of lab functions that would have been a real pain.

**COOK Report:** So, what exactly does it do, and how are you using it?

**Wilder:** Basically, it's a piece of software that can manage a radio testbed in a very flexible way. So, we've stood up an instance of that software, and I'm actually going back and forth with some folks from Guifi now about potentially even federating those instances across a VPN. A couple of the European sites that have instances are interconnected

that way, and we might actually join up with them and for a sort of global testbed.

**COOK Report:** That would be really neat. At any rate, the guifi.net software allows you to set up a network testbed in some virtualized form?

**Wilder:** That's exactly right. It allows you to manage a bunch of radios in such a way that you can try novel things with them, and have different firmwares virtualized simultaneously so that you can get feedback on the performance of different configurations.

**COOK Report:** Interesting. Suppose you wanted to test the performance of some new radios at some new points of interconnection with where you are in Kansas City. I would be surprised if this could actually test the feasibility of particular placements in such a situation.

**Wilder:** Right. It doesn't allow you test for link quality. It doesn't replace a site survey or an RF survey.

**COOK Report:** Can you plug GIS data in, and say "supposing I put a radio here, where would I have to put another radio to establish a link" - can you do that?

**Wilder:** That is definitely a part of FreedomCenter, and it's a capacity that Guifinet has built out in a very robust way, but it's not a part of this particular software. CONFINE has a very specific research and development focus, where what you're talking about, as you said, is more along the lines of GIS software.

**COOK Report:** So, what about the other places on the map? What about Neighbor.ly?



**Wilder:** Sure. Neighbor.ly is a civic crowdfunding organization that we've been working with in order to do a much larger scale, neighborhood-wide FreedomStack deployment there, perhaps in the next couple of months. It would be a fairly large starter network that folks could expand on their own terms. We are thinking of raising perhaps \$20,000 to \$25,000 from the surrounding community, and that would provide enough capital to plan the seed of a wider free network. The initial footprint would probably be about 8x8 [square blocks in the Crossroads](#).

**COOK Report:** And what about Harry's. What is that?

**Wilder:** That's a building owned by a supporter named Harry, at [the corner of 31st and Troost](#). Along with some folks from Occupy and my union local, we've been fixing it up, starting with the leaky roof. Up until the 80's, I believe it was a mall of sorts: with a nightclub, a restaurant, a hat shop, and some other merchants. Now there's nothing in it. Once we've restored it to better shape, it'll be the Osage Trail Entrepreneurial Development Center, with classroom and office space, and so on.. It stands at a very central, very high point, and has perfect line-of-site to Oak Tower, so we're planning to use it as one of our central FreedomTower sites.

**COOK Report:** MMF Radio?

**Wilder:** The Mutual Musician's Foundation recently got a permit to launch a low-power FM station, so they're putting up a mast, and they've agreed to let us put some microwave gear on there. It'll be a perfect distribution point into the 18th and Vine district.

**COOK Report:** [The 816 Garage? \(Shown below\)](#).





**Wilder:** That's a bike collective. They're a sort of voluntary association that works on old bikes and sells them for cheap or gives them away. They've got a building at 31st and Cherry that they're renovating, and they're very eager to put a FreedomTower there, which would help us cover the Union Hill neighborhood.

**COOK Report:** Westside?

**Wilder:** Westside is a senior center near 17th and Summit, on top of the bluff that stands between Kansas City, Mo and Kansas City, Kansas. It's the tallest building in the area, and would make for a great central relay for the west side, where Harry's building is on the east.

**COOK Report:** I see. So let's change gears here a little bit. I am curious how things are progressing with Google Fiber. Do you know anybody that has gotten a connection? Do you see any possibility for cooperation?



**Wilder:** Sadly, no. Of course, the main challenge is that it would be illegal. We live in a climate where violation of a Terms of Service agreement can result in a Federal indictment, so it doesn't seem worth it to risk it. What has happened is that, the public housing authorities, in addition to a really big chunk of the public have realized that while a decent number of folks, or people acting on

their behalf, were able to come up with the ten bucks to preregister – the shit has really hit the fan when it comes to actually getting the connections. People simply don't have the money. It's not happening. From my perspective, the reality on the ground is that where the city needs it most, very, very few people are getting connected. It seems more urgent than ever that there be some solution for ambient connectivity, and I think that's a big part of why there's so much energy behind what we're doing.

**COOK Report:** People are aware of the disparity, and they're thinking about what they can do about it?

**Wilder:** It's that, and they're also just coming to terms with the fact that a very small portion of the population is going to be helped at all by Google Fiber. That's the bottom line.

**COOK Report:** Well, it's going to be extremely interesting, that's for sure. So, to what extent is there going to be the possibility that there will be some middle or high school where some of the students have a Google Fiber connection at home, and others have nothing at all?

**Wilder:** It seems fairly likely, although Kansas City remains a deeply segregated city, by race and by class. Given that Google's map drawn on those same old race lines, I imagine that there won't be much overlap demographically. It's far more likely that some kids will go from a home where they have no connectivity at all to a school where they've got Google Fiber, and back to nothing in the evening.



# It Must Be Done

## *A Summary and Credo by Isaac Wilder*

Much of the material in this report has been gleaned from conversations, from clippings, from the outside looking in. This is my opportunity to look out, to tell you where we stand, what moves us, and why what we're doing matters immensely.

The first thing to understand is that we're in this for the long haul. We're just going to keep going, no matter what. Understand that we are dedicated to the idea of the network as a public good as deeply and as passionately as individuals can be dedicated to an idea. From my perspective, the reason is simple: what we've got today is broken, badly. It is downright painful to see the state of our knowledge infrastructure. For the first time in all history, we have the capacity easily within our grasp to make sure that no mind ever again goes hungry for knowledge. With this understanding, that we do not have to be beholden any longer to those that would deny us the the profound and sacred gift of knowledge -- *we cannot remain idle*.

There is no reason - technical, social, economic or otherwise - that connectivity should not be regarded as a universal and public good. It seems self-evident that the consequences of such a regard would serve to profoundly augment human flourishing. Someday, I am sure, there will be a global network, maintained through the voluntary association, goodwill, and self-interest of all. For the time being, it begins with the community, the locality, the tribe.

Horizontally organized network commons have been built using copper, fiber optics, free space optics, microwaves, and many other media of transmission. Much of the focus has been on microwave wireless, including fixed and mobile applications, where dramatically lower capital costs put larger build outs within the reach of ever smaller enterprises.

What was a newfangled and far-fetched idea just a decade or so ago, that communities can do for themselves what has long been the job of telecommunications giants, is now a manifest reality. Large scale community networks have blossomed, while the technical and economic barriers to their growth lessen, accelerate the decline of the giants. As the barriers come down, the networks go up - it is only logical: why would billions of humans continue to rent their ability to communicate, when they could as easily come to own such a capacity for themselves?

What we are witnessing is no less than the emergence of a global mind - the impulse to demand rent for the use of communications pathways holds us back as a society and a

species. The problems we face are too large, and the situation is too dire to think that we can afford to do anything less than reckon fully with our troublesome dependence on those that would keep us in a version of 21<sup>st</sup> century serfdom.

It almost goes without saying that information is now, more than ever, the engine that moves the world. With electricity, with heavy industry, with agriculture before that, the way that we relate to our most advanced technologies is necessarily reflective of the macro power structures of civilization.

We intend to challenge and transform those structures, and we believe that DIY internet is exactly the right place to start. Those who do it have a stake in the outcome. They become producers rather than just detached consumers. Organization starts with communication, and our lines of communication cannot be contingent on the cooperation of entities whose paramount interest is the indefinite perpetuation of the *status quo*.

There is very much work to be done. We have the tools that we need to get started, and to have an immediate impact on the lives of many, but the fact remains that we need better tools. We have, first and foremost, to make it easier to build free networks. There are only so many folks that are willing and able to learn the technical aspects of computer networking – there are many more, (though still a limited number) that would be willing to organize their communities, if only they had the right tools. I make this assertion based on the notion that late capitalism leaves most all of its subjects in a state of deep discontent. Given the choice to continue acting as a born-and-bred consumer drone, or to take part in the construction of something new and world-changing, it is doubtless that most will drone on – a few though, will find meaning in the work of species-scale cooperation. We have to make it possible for those few to contribute in a meaningful way.

More than that, we need to push the very limits of what is possible. The microwave hardware available today off-the-shelf is intended for use in contentious networks, where radio signals interfere and collide with one another by design. Looking towards the horizon, it is critically important that we increase the practicability and decrease the cost of radio systems that are spectrum-sensing, adaptive, and cooperative. Ultimately, it will be essential that we produce systems in which capacity goes up in at least a linear relation to the number of nodes. Such systems have been proven theoretically, but at the level of physics and media access, today's systems don't come close.

We know that there is very much to do, and it is for this reason that we are taking care to build as solid a foundation as we possibly can. We are gearing up for a struggle. From where we stand, this is something that simply has to happen. If we are to save the planet from ecological disaster, if we are to achieve social justice, if we are to live free, we simply must make provisions for a network commons born of social production.

## **A Note from the Editor:**

I strongly endorse Isaac's credo as written above. As corporation go, Google is superb. However, being publicly-held it must, according to current belief, act to benefit its shareholder first of all. I know Milo Medin and sent him a final draft of this article. Not surprisingly, he disagreed with Isaac's comments about his company. In my opinion, corporate actions can be viewed differently by people on different sides of the economic fence. I think that is the situation here. A desirable end would be for FNF and Google to cooperate. In the meantime perhaps they could use Connecting For Good as neutral ground for conversation. Isaac is giving the community organizations which he works with a strong stake in the outcome. This is good. This is something that I would like to see a lot more of. Citizens, rather than corporations, would be likely to come out the winners - an outcome that we seldom see these days. If our nation is to survive on the basic principles drawn up by our nation's Founders, it is something we need to see happen much much more.

# Conclusion

## *Not an End but a New Beginning* by Jeff Michka

Both guifi.net and Kansas City FreeNet are examples of alternative networks and connectivity oriented toward user needs and, in large measure, created by users. These are true alternative paths to the connectivity provided *exclusively* by corporate entities motivated by simple profits and market share.

### **Why To “Do-It-Yourself” and Really Practice “Do-It-Ourselves”**

These new user-created networks are not only technically possible, but practical in application – built not because networks are “cool” and everyone ought to have one, but because building them would address mutually recognized and shared problems of those served by these networks.

Like most innovative approaches to applied technology, both concepts (guifi.net and Kansas City FreeNet) were born of the desires and needs of those providing seeds for their network development. Neither were these networks created to carve out personal empires of wealth and control or meant to be springboards to position, big salaries and stock options at the eventual expense of the constituencies served. As a result, their network designs, development and deployment were products of the old, tried and true reality of “form follows function.”

In Catalonia, Ramon Roca started because he wanted to telecommute from his regional residence of choice, and could not. Ramon intuitively struck out to find a solution resulting in guifi.net. Here in the United States, Isaac Wilder’s journey began as part of his socio-political perceptions, combined with a deep passion for social justice.

The two efforts detailed in this issue of ***The Cook Report*** face both technical and non-technical challenges, as well as other issues that must be kept in mind when examining or comparing them. Perhaps most important are the economic, cultural, social and political differences between Catalonia (and EU) and those found in the United States.

Other issues affect efforts, mostly here in the US, and are worth only passing acknowledgement due to their nature and scope, but must be kept in mind. For example, although a stated reason for creating Kansas City FreeNet, was filling in for what Google would not be doing, it seems pointless to obsess over behaviors of Google or other heavily-monetized, extractive corporate entities which are designed to create a profit for their owners. This goal is why commercial, for-profit enterprises exist.

Here and elsewhere in the World, corporate, capitalist entities will continue to do what they do best: Make money. Making money will always be their goal. Given cost and profit models, they will tend to serve those that can pay (and pay and pay), and will either underserve or not serve people, neighborhoods, communities and regions where – regardless of reason – individuals are unable to pay as contribution to meet corporate-defined profit margins.

In the US, or in Catalonia with Spain's Telefonica, it should come as no surprise to anyone that telcos and cable companies will act like telcos and cable companies have always acted or tried to act: like monopolies any time given the chance. With continued federal regulatory dysfunction at FCC in the United States, and recognizing a higher and almost total dysfunction at a federal legislative and policy level, nothing will effectively stop these giants from behaving as predatory monopolies, despite any individual efforts.

At a US state regulatory level – PUC commissions – the same monopoly players have other factors in their favor. Like virtually all state and local governments, monetary resources have become scarce.

Money in budgets equals FTEs (Full Time Employees). Knowledgeable and competent staffs supporting state regulatory agencies have fallen under the budget axe. At best, wise counsel from staff has been almost eliminated in many states, and with almost unlimited capital resources, it becomes far easier for MSOs and other incumbent telecommunication providers to hold absolute sway over their regulators and elected officials. As a result, and at best, state regulators and elected officials will accept what MSOs and incumbents tell them, regardless of how erroneous proponent arguments might be in absence of any countervailing voices, even from staff. So-called public interest or real, direct-to-the-public-benefits are usually the first victims in these environments.

At a municipal level, even scarcer monetary resources may mean any corporate-tied offer "to do something at reduced cost" becomes almost impossible to resist, even though it's obvious the citizens these local elected officials ostensibly serve will not all be served by the corporate entities they curry favor with. The cities get an offer they can't refuse. They can have their cake consisting of restricted-access or very limited-access municipal networks or broadband access without investing much of the jurisdictional dollar, and eat all of it too.

These trends are not going to change any time soon, and again, no single effort will undo or stop these aforementioned trends. The trends must be kept in view, but not obsessed over as a total distraction from the business of creating and deploying new networks as remedies where necessary.

Given the necessity for people to access information and other products the Internet offers, for example job info and applying for work, medical info and social services, education opportunities, including free university courses -- price and access are barriers with long-term negative and almost tragic socio-economic consequences. Kansas City FreeNet

and guifi.net models provide some way out for those trapped by location, economic and social status, as well as directly involve affected people in creating their own solutions. In full recognition of governments being no longer able to provide workable solutions or answers, these network models become clear and practical alternatives with many more potential benefits to those involved in their creation.

## **We've got the Tools and Talent: We Are Not Alone**

In long-held traditions having little to do with the Internet, guifi.net and Kansas City FreeNet have decided to build alternative networks on what they call a "Do It Yourself" (DIY) basis.

The technological means to create networks employing a "DIY model," as Ramon and Isaac call it, are clearly detailed in this issue of ***The Cook Report***.

For tinkerers or home owners anywhere, DIY can be a cost-effective and deep, personally satisfying effort when a success, and even when things don't quite work out. Ask someone who put on their own roof, then finds it leaks. The reaction is "I'll fix it and make it better next time," or they may just put down a few buckets, still glowing with personal satisfaction, then fix the problem later. But DIY, despite outcome, is still a singular effort defined and limited by the word "Yourself."

Is it fair to say these alternative network initiatives are really just "Do It Yourself"?

Neither Ramon nor Isaac would say of their visions, "I built this." There are many other individuals and organizations making up the vital constituencies of both models and participating in their genesis and growth. Ramon clearly acknowledges this within the guifi.net's "Three Pillars."

Both visioneers would be the first ones to admit it. A whole lot of people – technical professionals and individuals are working in concert, building and deploying these networks, whether pulling fiber in Catalonia or putting up radio antennae or doing signal strength studies in Kansas City.



## Wouldn't it be Far Better to Say "*Do It Ourselves?*"

Do It Ourselves (DIO) is an important and powerful phrase through which to view many, if not all aspects of guifi.net and Kansas City FreeNet. It's an important and crucial up-front statement not only to those viewing these networks, but by people with technical expertise and those without that background, creating them from the bottom up to ensure, in total, ***the network remains as means to end, and not an end in itself.*** It's not just the network, it's *everyone* involved in making it happen.

The phrase "Do it Ourselves" conceptually helps break down with a single phrase participant barriers created by potential self-aggrandizement and self-interest at the front end. It's an important premise in design and deployment as part of an *overall* project environment, signaling from the outset we are not alone in these pursuits, and taking it into account at every phase of the project.

Do it Ourselves is a signal to all participants that, by default, they must commit to working with each other and learning about the tasks at hand. This requires professionals to reach out and teach, too. No, few "average" people will embrace or be able to grasp difficult technical concepts and procedures, but some will want to try if encouraged and sustained.

DIO is an equally vital way to view long-term network resilience, sustainability and reasoned growth – what can be done and by whom – as the network is deployed and matures. It's a simple way to look at how these and other similar efforts can govern themselves, introducing ***Commons principles*** as organizational covenant, structure and guidance for how these networks develop and are used over time.

DIO sets a tone for how participants will see their efforts from the beginning and looking back at results: **We did it ourselves.**

A DIO attitude and effort is particularly important in the US.

Here, people do not have the same social compacts and experiences of those in Catalonia where cooperative behaviors are accepted and traditional ways of going about things in agriculture and related pursuits, having absolutely nothing to do with the Internet or building alternative networks.

As a result of this difference, in the US, alternative network development of any technical flavor – mesh wireless or hybrid variants -- will have to go hand-in-hand with some very basic grassroots-organizing techniques, education along with technical evangelism, even in locations with strong neighborhood and community organizations. People will need to be educated and convinced as to how cooperative action, Commons principles and open access can directly benefit them and how, regardless of the technical aspects of the network itself.

It can be done, but adds an additional layer of complexity probably not found, for example, in Catalonia. For alternative network proponents in the US, Ramon Roca's observation "If we take on a new project and don't provide positive results, the local people we're trying to work with will get discouraged" must also be taken as a very basic organizing principle and consideration.

Promising too much in too short a development curve without tangible results will discourage constituents, no matter where, so developers need to carefully map out progress and define expectations well in advance.

This consideration becomes important when mesh wireless-only networks are the mechanism of choice or necessity. Although a mesh wireless network is easier to create, particularly with out-of-the-box tools like those software tools guifi.net has developed, and with less expensive hardware costs and deployment, some pretty steep expectation challenges could impact results.

For example, mesh wireless-only network performance and service levels will remain issues. If people's expectations are that they will stream Netflix HD 24/7 as a primary use of these networks they helped build, then they might well be disappointed. If the expectations are that high school students will no longer have to stand outside their school to use a nearby business' wi-fi hotspot to do homework or apply for work or college, then people might be well satisfied with results of their efforts and want to do more. ***People may be well satisfied if technological limitations do not compromise why the network was created to begin with.***

Other challenges, far more transparent to constituents and neighborhood stakeholders less than tech-savvy, but of great concern to professionals, include problems of crowding 802.11 category spectrum, and perhaps as a result, the future practical use of unlicensed spectrum in general, even considering innovations in spectrum usage with software-defined radio.

Guifi.net, given the political and regulatory environment in Catalonia or EU nations in general, can deploy their own fiber as needed to ensure performance and interconnection. Do it Ourselves broadband initiatives are being encouraged in EU, while discouraged by default and other factors in the US. See <http://dev.bub4eu.net/>

Wireless mesh interconnection in the US will require some really creative work-arounds and efforts on the part of alternative network proponents and technical personnel if Commons principles (at several levels, including content licensing), open source and P2P networking are to be deliberate functions of overall network design and intent. It's a big challenge to successful wide deployment.

Can it be solved here in the US? That remains to be seen over time.



## Taking Time

Mentioning “over time” brings up another “challenge point of comparison” between Kansas City FreeNet and guifi.net. Guifi.net has taken 10 years to develop to where they are now. Kansas City FreeNet has existed for just months.

Isaac Wilder should be complimented on Kansas City FreeNet coming so far so quickly. It’s remarkable in many ways. It does beg questions on how they will structure themselves to grow, given *all* factors, and remain vital and active in neighborhoods and in the wider community they serve. Those questions are not answered yet, but this is no surprise given how early-on the effort is. Their efforts cannot be judged exclusively for this reason alone, and must be applauded.

Again, Do it Ourselves attitudes may be a key as to how this happens over the long haul in Kansas City or elsewhere in the US. The real strength of these networks will not be measured by just the technical framework and professional-level individuals building frameworks, but measured by the combined strength and effort of *all people and groups actively involved* with making them happen.

As an adjunct to ensuring involvement, and keeping in the spirit of promoting network as Commons, alternative network proponents must embody Commons concepts in their covenants and operating agreements.

Guifi.net, in 2006 adopted their Comuns XLON, a covenant and contract between and among all participants that clearly states purpose of a declared Commons, and codifying an open-access, peer-to-peer network. The covenant spells out participant responsibility to the network and other participants in guifi.net.

Roger Baig Viñas of guifi.net describes the attraction guifi.net projects and the evolution of the Commons concept pre-adoption and its eventual codification:

“ I decided to join [guifi.net](http://guifi.net) the same day I knew about the project because it offered me a clear hands-on project, a clear way to start working for changing things. The problem to address was pretty well defined: a key infrastructure ("the internet") that has been hijacked by a few companies and lobbies (Telefonica in the very first place, . . . etc.) and an incipient technology ("the WiFi") becoming available to start building an alternative, not only to do things as they had to be done by a theoretically sane capitalist system but much better.

At that time we hadn't had the theoretical fundamentals as we have now (built mainly around the Commons concept) but we had the intuition (thanks to the clairvoyance of Ramon - and maybe a few others) that we were doing the things the right way. It's been during this process of theorization combined with an intensive fieldwork that we (at least I) understood that our model (the model based on Commons) could easily be extrapolated to many other areas, infrastructures, and services. Actually I am not able to think about any area where it cannot work. As I already said to you, one of the things I like the most is the fact that this model both enables and needs commitment from the people.”

This type of agreement, other than ensuring open access and interconnection, is a means of promoting Commons thinking and can, as covenant, also ensure a level of trust among participants. This element of trust-by-covenant principle is a big step in trust building between constituents, taking the place of corporate, for-profit Terms of Service (TOS), for example.

Too often TOS, in a for-profit setting, is ignored until some problem arises. And then it used as a club, or excuse, to bar access, resolve "problems," or deny responsibility. The same corporate entities are also the first to break trust with consumers when it comes to promised deployments, rate hikes and system performance, to name three frequently broken deals.

An elegant and reasonably simple agreement like guifi.net's Comuns XLON states all requirements and expectations upfront. When combined with stated goals and reasonable expectations of results from an alternative network, an extremely powerful package has been created to build trust and ensure behavior by **all** participants that lend to Commons thinking in real application.

In addition, particularly in the US, the same clear and purposeful declarations should be included in a alternative network's incorporation bylaws, regardless of what non-profit tax classification (for example, 501c(3) or 501c(10)) they choose to take as their legal structure.

Although guifi.net's thinking evolved over time, reinventing the wheel is not necessary any longer given their outstanding example. As Roger has pointed out, it can be applied anywhere. This must be part of alternative network development from the beginning.

Once again, these covenants have little to do with the technical aspects of a network, but have everything to do with ensuring success in the face of some very daunting but exciting challenges to deployment and potential promise.

Can guifi.net come to the US and succeed? Yes. Can many Kansas City FreeNets flourish? Yes.

Will it be easy? Probably not, but development and deployment of these alternative networks is absolutely necessary to break the weight of corporate chains and roadblocks to an open access Internet based on Commons principles and the free exchange of ideas, hence liberating those that are not yet served, as well as those treated as digital serfs and passive consumers ripe for fleecing in the US and around the World.

If not now, when? The time has come today.

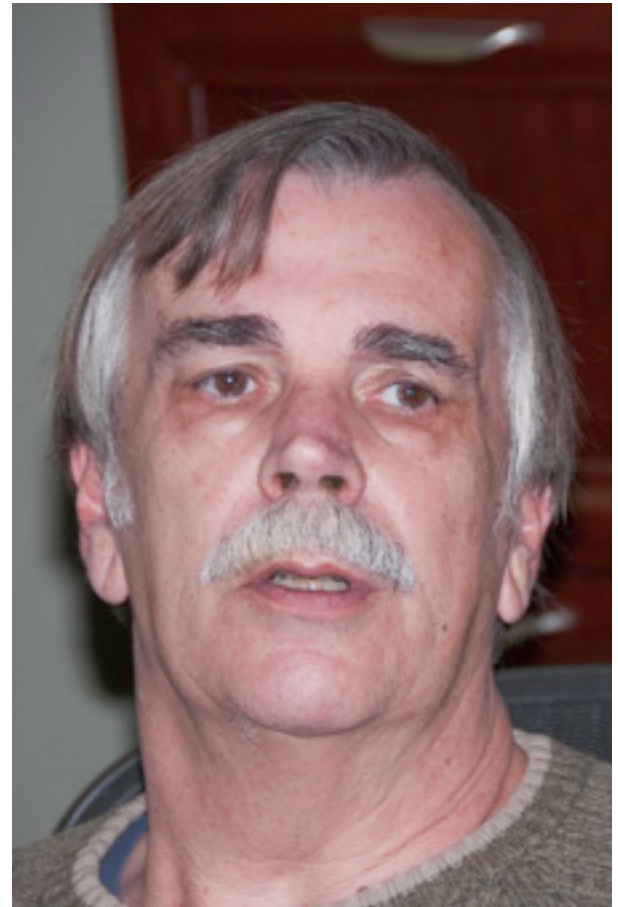

**Jeff Michka and the Editor went hiking in 1993 and saw each other again in 2011**

**Jeffrey Michka** is a technical writer and engineering administrator and information specialist having held many private-sector IT positions over his career. Jeff has also been a long-term broadcaster in commercial and noncommercial community radio, including program cohost and producer of "Technical Difficulties: People, Power and Information," as heard on NW public radio. He was active in developing information policy for citizen organizations, and improving public access to public records in electronic form as founder and project director of Washington Community InfoSource BBS network (WCIS), Citizen Online and as a lobbyist for public-interest/citizen organizations. Michka cofounded several community and public-interest organizations in Washington State and is a former Secretary and board member of the Coalition of Washington Communities (CWC). Jeff currently resides near Seattle, WA.

## Dave Hughes the “Cursor Cowboy”

### Comments on February 1, 2013

1. You blame cable and Comcast (and its European counterpart) for highjacking the promise of open Internet communication. Fair enough, since all commercial telco's have hated 'unlicensed' wireless from its origin in FCC and its European Counterpart rules. They think that ALL communications should cost whatever the market will bear. And clueless politicians have loved to require the FCC to 'auction' all available spectrum (1) to fill government coffers and (2) perpetuate the idea that all mass communications should be based on 'market' forces. 'Free' user spectrum is a political anathema.
2. There IS a large, and growing, legitimate, competitive 'commercial' industry in digital radio. It is the industry of designing, marketing, and selling Digital RADIOS, which connect up 'free' (unlicensed) net traffic. But even there, the Regulators have the last word on government (FCC) approved unlicensed radio design - what frequencies, protocols, bandwidths, power-limits and channels they can manufacture into their radios.
3. Now your grass-roots, do it yourselves, bottom-up community networks can grow with its mixture of fiber lines and unlicensed radios UNTIL the amount of traffic (where the only real costs are those incurred at commercial servers that connect up the essentially free 'community' networks (or at least not charged, ala Comcast, for every pipe per month and in the future 'by load') starts seriously to COMPETE WITH the Comcasts of the world. Which want to charge for every bit.
4. That is when the Comcast type large corporate telcos, benefitting their stockholders, will weigh in at the Government wireless Regulatory level to get the wireless rules changed - to limit, hamper, block (at the IP level?) such 'free' (or co-op paid for) networks. By Church-steeple or cottage-on-the-lake level. And they will do it through their politicians.
5. ***The Catalonia network seems not to have run into any of the obstacles I point to above.*** But as I said "No good deed (community communication) goes unpunished" I wonder if the Spanish politicians in their parliament are really aware of the current community-built network. Or understand its sophisticated evolution and 'ownership'. (I know some large Telephone companies who would be glad to 'educate' them)

Two examples.

1. I had to virtually sneak into Kathmandu, by putting Cisco's granted 'VOIP' radios on the bottom of my luggage past customs, in a country whose telco was government owned, and which I learned neither liked wireless nor VoIP. while I set up to let the Sherpas you introduced me to communicate around the world with Skype at only the incidental cost of the satellite telco bypass.
2. When the Welsh National Assembly paid me to show the really rural Welsh, for whom British Telecom would either NOT extend even lousy ISDN to small communities, or charge a bundle for terrible bandwidth, I was showing them how to do it free - by farmhouse or Pub to the closest network (university

in my case) using Cisco radios which SPECIFICALLY allowed only 1 watt EIRP under EU and UK rules. (While the same radios in the US can use 4 watts EIRP.)

Even then, as I lectured, demonstrated across Wales from Cardiff to Carnarvon, BRITISH TELECOM FOLLOWED ME and after I left, like a university, they would ASK whether or not THEIR service was satisfactory to that institution, company, or pub since they were looking at alternatives. They even, when I demonstrated at the grand, large, annual Eisteddfod and linked up many venues wirelessly, BT actually had a tethered large balloon, wired to the ground which SCANNED the Spectrum I was using! To see if I was breaking any government rules for wireless.

In the end the looming COMPETITION that unlicensed wireless could pose to BT, caused them to LOWER their rates for even lousy net service.

Ok, I think I have made my point about what else has to be thought about projecting into the future, when 'community' wireless Internet collides with 'corporate' and is studied by 'government.'